

MB901SPR-B R1



(FatCage RAID)

2 Bay 2.5"/3.5" SATA SSD/HDD RAID Backplane Cage for 2 x 5.25" Bay



MB902SPR-B R1

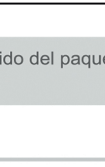

(ToughArmor RAID)

Rugged 2 Bay 2.5" SATA SSD/HDD RAID Mobile Rack for 5.25" Bay

Scan the QR code for more product information

Copyright © ICY DOCK International. All Rights Reserved. 6503022 VER 3.0

Cremax Europe GmbH  
Email: support@icydock.com  
Weidenweg 21H, 47059 Duisburg, Germany

UK Beyond Technologies UK Ltd  
Email: info@beyondtech.co.uk  
Unit B6, Halesfield 11, Telford, Shropshire, TF7 4PH, U.K.

## 1

Package Contents • Packungsinhalt • Contenu • Contenido del paquete  
• 包装について • 包装説明 • 包装说明

### MB901SPR-B R1

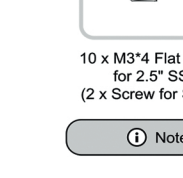

Device

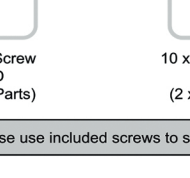

User Manual

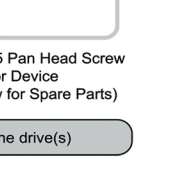

10 x M3\*4 Flat Head Screw for 2.5" SSD/HDD (2 x Screw for Spare Parts)

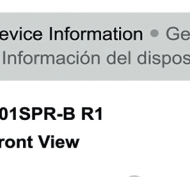

10 x #6-32\*6 Flat Head Screw for 3.5" HDD (2 x Screw for Spare Parts)



10 x M3\*6 Pan Head Screw for Device (2 x Screw for Spare Parts)

### MB902SPR-B R1

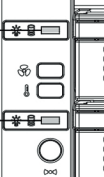

Device



User Manual

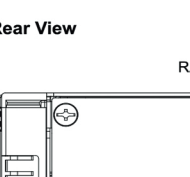

10 x M3\*4 Flat Head Screw for 2.5" SSD/HDD (2 x Screw for Spare Parts)

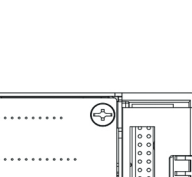

10 x M3\*2.5 Pan Head Screw for Device (2 x Screw for Spare Parts)

Note: Please use included screws to secure the drive(s)

## 2

Device Information • Geräteinformationen • Informations dispositif  
• Información del dispositivo • 本体説明 • 機體說明 • 機體说明

### MB901SPR-B R1

#### Front View

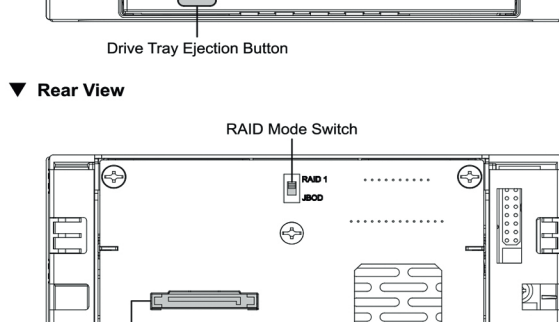

Drive Tray Ejection Button

#### Rear View

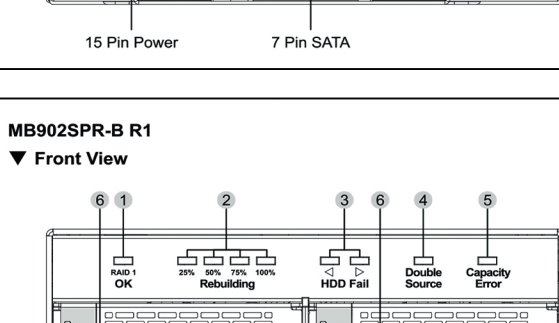

15 Pin Power

7 Pin SATA

### MB902SPR-B R1

#### Front View

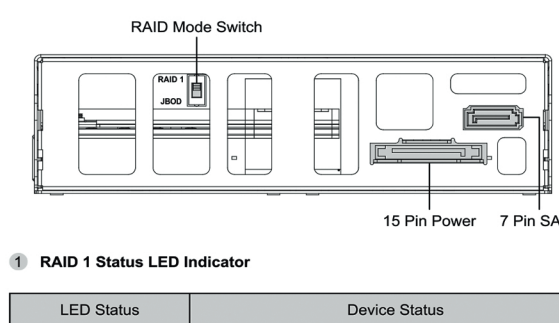

Drive Tray Ejection Button

#### Rear View

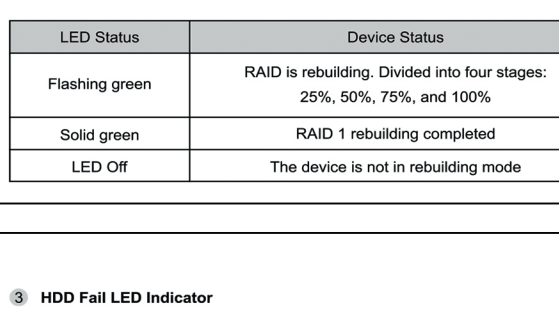

15 Pin Power

7 Pin SATA

#### 1 RAID 1 Status LED Indicator

LED Status	Device Status
Solid green	RAID 1 array is working properly
LED off	JBOD / rebuilding / drive Fail / RAID error

#### 2 Rebuilding Progress LED Indicator

LED Status	Device Status
Flashing green	RAID is rebuilding. Divided into four stages: 25%, 50%, 75%, and 100%
Solid green	RAID 1 rebuilding completed
LED Off	The device is not in rebuilding mode

#### 3 HDD Fail LED Indicator

LED Status	Device Status
Solid red x 1	Indicate a fail drive / target drive's capacity is smaller than the source drive
Solid red x 2	Double source drives

#### 4 Double Source LED Indicator

There are two source disks in the device. Replace one with a formatted or brand-new drive.

LED Status	Device Status
Solid red	Double source drives

#### 5 Capacity Error LED Indicator

The capacity of the target drive you insert is smaller than the source drive in the device and causes rebuilding failure. Therefore, please use a drive that has the same or larger capacity than the source drive.

LED Status	Device Status
Solid red	Capacity error

#### 6 Drive Activity LED Indicator

LED Status	Device Status
Solid green	Drive power / processing RAID 1 rebuilding (source drive)
Flashing green	Drive access / processing RAID 1 rebuilding (target drive)
Solid red	Drive fail / double Source / target drive's capacity is smaller than the source drive

## 3

Installation Guide • Installationsanleitung • Guide d'Installation • Guía de instalación • 製品の組み込み手順について • 操作步驟 • 操作步驟

1. Slide the drive tray ejection button to release the drive tray latch. Next, pull the drive tray from the device.

### MB901SPR-B R1

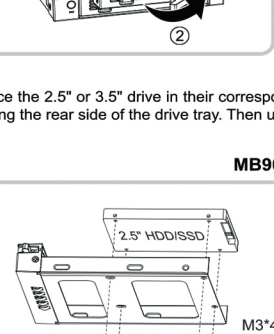

### MB902SPR-B R1

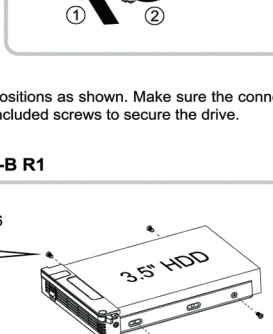

2. Place the 2.5" or 3.5" drive in their corresponding positions as shown. Make sure the connector is facing the rear side of the drive tray. Then use the included screws to secure the drive.

### MB901SPR-B R1

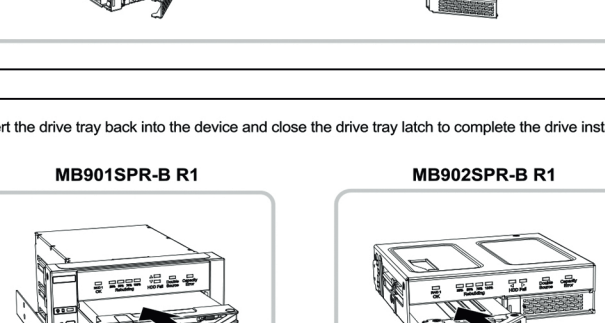

### MB902SPR-B R1

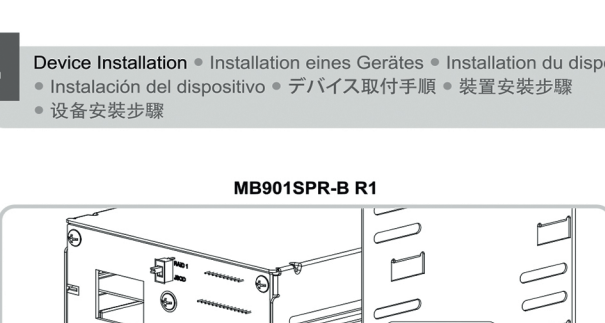

3. Insert the drive tray back into the device and close the drive tray latch to complete the drive installation.

### MB901SPR-B R1

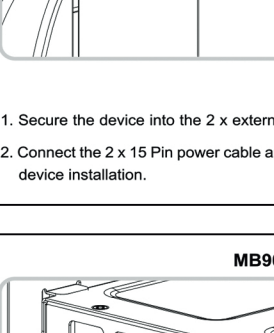

### MB902SPR-B R1

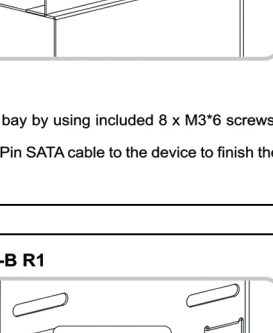

## 4

Device Installation • Installation eines Gerätes • Installation du dispositif  
• Instalación del dispositivo • デバイス取付手順 • 装置安裝步驟 • 设备安装步骤

### MB901SPR-B R1

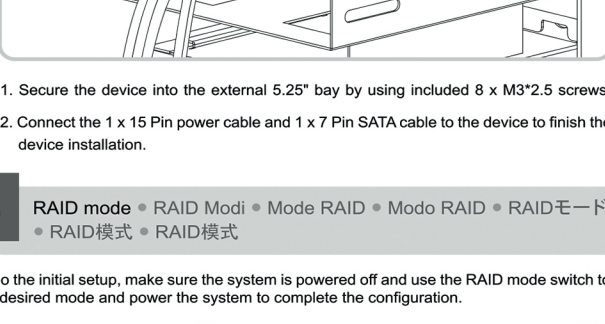

1. Secure the device into the 2 x external 5.25" bay by using included 8 x M3\*6 screws.

2. Connect the 2 x 15 Pin power cable and 1 x 7 Pin SATA cable to the device to finish the device installation.

### MB902SPR-B R1

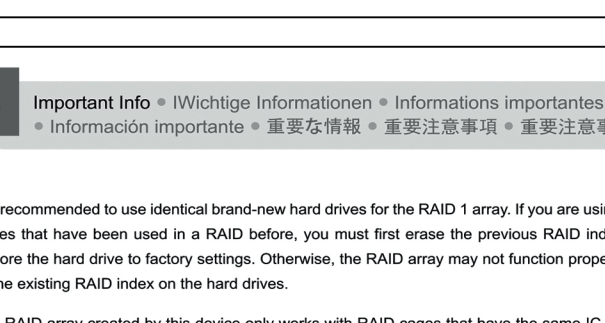

1. Secure the device into the external 5.25" bay by using included 8 x M3\*2.5 screws.

2. Connect the 1 x 15 Pin power cable and 1 x 7 Pin SATA cable to the device to finish the device installation.

## 5

RAID mode • RAID Modi • Mode RAID • Modo RAID • RAIDモード  
• RAID模式 • RAID模式

1. To do the initial setup, make sure the system is powered off and use the RAID mode switch to select the desired mode and power the system to complete the configuration.

RAID1(SAFE)



JBOD(NON RAID)



The two physical drives are "mirrored" so that one single logical volume mounts on the desktop. All of the data on one drive will be recoverable from the other drive (the available capacity of one drive cannot exceed the available capacity of the other drive).

The two physical disks are read as two independent hard drives in a single housing. Therefore, the computer will show two separate drives.

Note: In case both drives fail at the same time, it is recommended to backup any stored data onto another HDD periodically for extra security.

Note: While in JBOD mode with Port-Multiplier, make sure that your system supports Port-Multiplier in order to detect both drives. If not, only the top drive will be detected.

#### Note:

- Setting up JBOD/RAID 1 array or switching between the RAID modes will erase any data stored in the drives. Be sure to backup the data before the operation.
- To erase the RAID index previously created - Power off the system, switch to JBOD mode, and power on the system to complete the process.

## 6

Important Info • Wichtige Informationen • Informations importantes  
• Información importante • 重要な情報 • 重要注意事項 • 重要注意事項

- It is recommended to use identical brand-new hard drives for the RAID 1 array. If you are using hard drives that have been used in a RAID before, you must first erase the previous RAID index and restore the hard drive to factory settings. Otherwise, the RAID array may not function properly due to the existing RAID index on the hard drives.
- The RAID array created by this device only works with RAID cages that have the same IC chipset and firmware version. Moving the drives to the RAID cage that uses a different chipset and firmware will cause data loss.
- If the drive access LED does not function properly, but you can access the drive could mean the drive does not support drive access signals or use non-standard drive signal specifications. Please get in touch with our support if you believe it is an LED malfunction.
- It is recommended to use ERC (Error Recovery Control) supported hard drives for the best RAID performance.
- If one of the hard drives malfunctions under the RAID 1 mode, the HDD fail indicator light will turn red and indicate which drive has failed. To start the RAID rebuilding process, simply remove the failed hard drive from the enclosure and insert a working hard drive with identical specifications while the enclosure is powered. The HDD fail indicator light should disappear in a few seconds, and then the rebuilding process will start promptly. The newly inserted drive will become a target drive, while the remaining hard drive will become a source drive.
- The RAID cage will perform a data rebuilding verification when swapping one of the hard drives under RAID 1 mode. The rebuilding verification process takes about ten minutes to verify/rebuild 100GB drive capacity. The processing time may vary depending on the hard drive's specifications.
- Never replace both of the drives under RAID 1 mode**, as doing so will cause the drive cage to rewrite the RAID table and corrupt the data saved in the RAID array. Note this action is not reversible and will erase all the data permanently.
- Please do not use the RAID cage for drive duplication or change the drive orders under RAID 1 mode, as doing so may cause data loss due to misplacing the source and target drives.
- Removing or changing the hard drive in RAID 1 mode during the rebuilding progress may result in data loss.

## 7

RAID Monitoring Software • IRAID-Überwachungssoftware • Logiciel de surveillance RAID • software de seguimiento del RAID • RAID管理ソフトウェア • RAID監控軟體 • RAID監控软件

The RAID monitoring software supports both Windows and Mac OS. Please visit <http://icydock.com> and download the software from the product page, located at Support & Download section:

a. Please ensure the device is installed in the computer and powered, and then double click



to launch the monitoring software.

b. The RAID status will display on the main page of the software.

